

A	470x38x24
B	414x38x24
C	470x376x4

Dept.	Technical reference	Created by thomas arnesen 2026-04-06	Approved by	
https://openhiveplans.org		Document type	Document status	
		Title Hive Langstroth	DWG No.	
Rev.	Date of issue	Sheet 1/4		

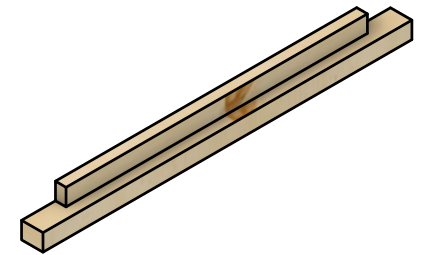

Dept.	Technical reference	Created by thomas arnesen 2026-04-06	Approved by	
		Document type	Document status	
		Title Hive Langstroth	DWG No.	
		Rev.	Date of issue	Sheet 2/4

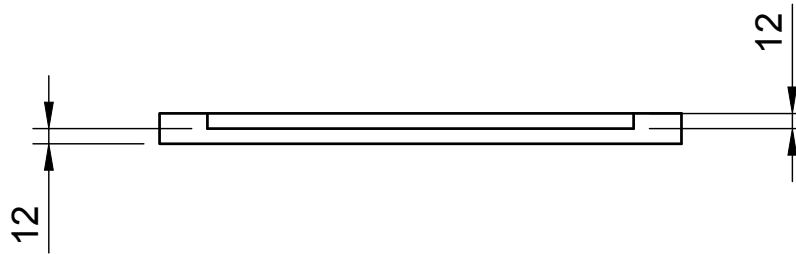
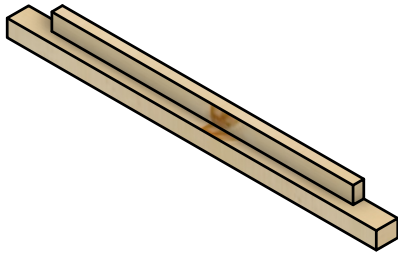
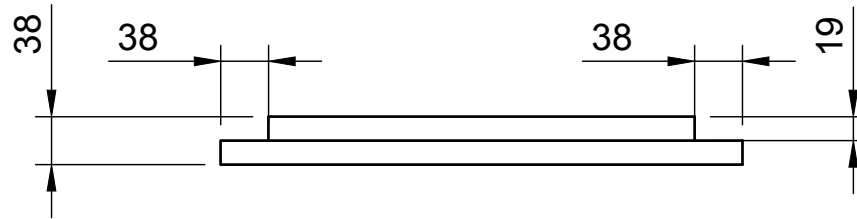
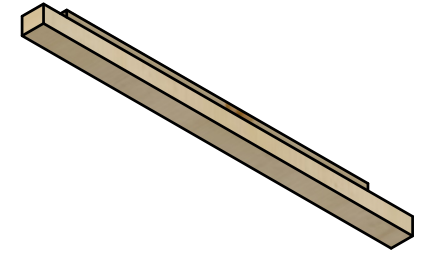
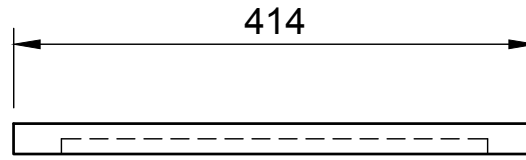
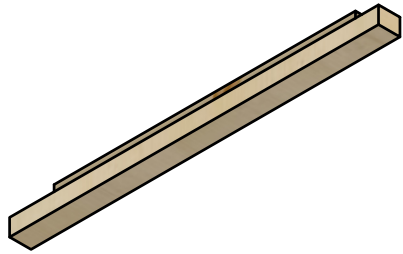
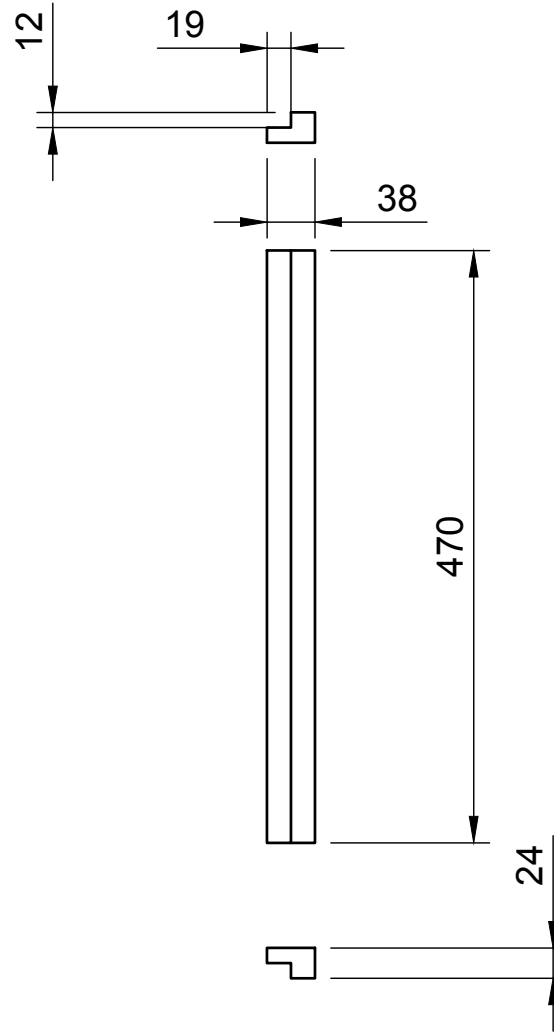
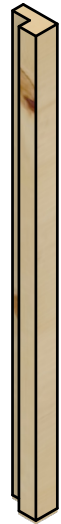
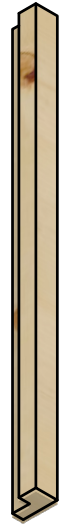

Dept.	Technical reference	Created by thomas arnesen 2026-04-06	Approved by	
		Document type	Document status	
		Title Hive Langstroth	DWG No.	
	Rev.	Date of issue	Sheet 3/4	

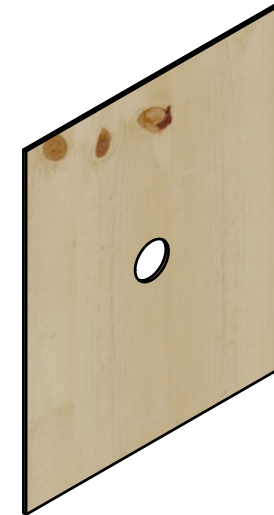
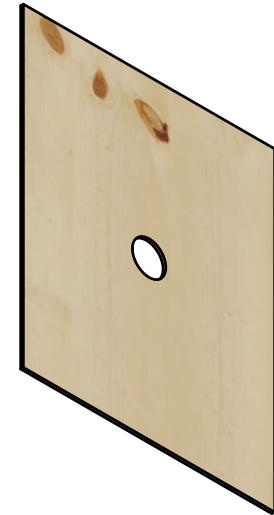
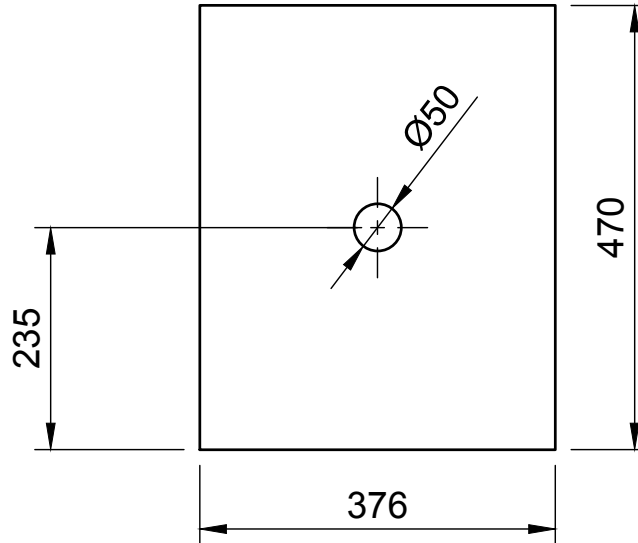
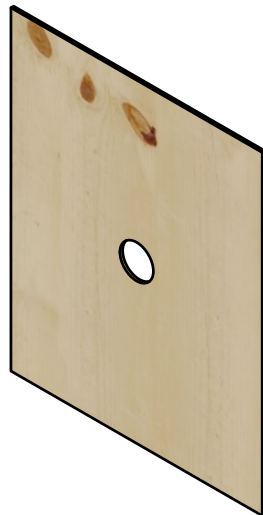

Dept.	Technical reference	Created by thomas arnesen 2026-04-06	Approved by	
		Document type	Document status	
		Title Hive Langstroth	DWG No.	
		Rev.	Date of issue	Sheet 4/4